

DS-2PT5326IZ-DE (5-50 mm)(4 mm) Triple-Directional PanoVu Camera with PTZ



Overview

Hikvision DS-2PT5326IZ-DE (5-50 mm) (4 mm) Triple-Directional PanoVu Camera with PTZ, is able to capture 240° images with the panoramic cameras, as well as close-up images with the PTZ camera.

System Functions

- 3-ch panoramic images in different directions and 1-ch close-up image
- Three flexible cameras are adjustable along a circular track, slide range: 0° to 270°
- Three flexible cameras can tilt rotate from 15° to 55° independently
- 1-ch audio input and 1-ch audio output
- 1-ch alarm input and 1-ch alarm output, support alarm linkage
- PTZ linkage
- Built-in memory card slot, support microSD/SDHC/SDXC, up to 256 GB
- Open-ended API, support ONVIF, ISAPI, and CGI, support HIKVISION SDK and Third-Party Management Platform
- Support H.265 video compression
- IP66

Panoramic Camera

- Three 1/2.8" progressive scan CMOS
- UP to 3-ch 1920 × 1080@30fps resolution
- Min. illumination:
Color: 0.005 Lux @(F1.6, AGC ON)
B/W: 0.001 Lux @(F1.6, AGC ON)
0 Lux with IR
- Horizontal FOV: 80.7° × 3
Vertical FOV: 43.5°
- Up to 30 m IR radius

PTZ Camera

- 1/2.8" progressive scan CMOS
- Up to 1920 × 1080@30fps resolution
- Min. illumination:
Color: 0.005 Lux @(F1.6, AGC ON)
B/W: 0.001 Lux @(F1.6, AGC ON)
0 Lux with IR
- 10× optical zoom, 8× digital zoom
- Up to 50 m IR distance



DORI

The DORI (detect, observe, recognize, identify) distance gives the general idea of the camera ability to distinguish persons or objects within its field of view.

It is calculated based on the camera sensor specification and the criteria given by EN 62676-4: 2015.

DORI	Detect	Observe	Recognize	Identify
Definition	25 px/m	63 px/m	125 px/m	250 px/m
[Panoramic Camera] Distance (Tele)	58.2 m (190.9 ft)	23.1 m (75.8 ft)	11.6 m (38.1 ft)	5.8 m (19.0 ft)
[PTZ Camera] Distance (Tele)	683.6 m (2242.8 ft)	271.3 m (890.1 ft)	136.7 m (448.5 ft)	68.4 m (224.4 ft)

Specification

Panoramic Camera	
Image Sensor	Three 1/2.8" progressive scan CMOS
Min. Illumination	Color: 0.005 Lux @(F1.6, AGC ON) B/W: 0.001 Lux @(F1.6, AGC ON) 0 Lux with IR
Shutter Time	50 Hz: 1/25 s to 1/30,000 s 60 Hz: 1/30 s to 1/30,000 s
Day & Night	IR Cut Filter
Gain	Auto/Manual
WDR	Digital WDR
Smart Image Enhancement	HLC/BLC/3D DNR/Defog/Regional Exposure
White Balance	Auto/Manual/ATW (Auto-Tracking White Balance)/Indoor/Outdoor/Fluorescent Lamp/Sodium Lamp
Privacy Mask	4 × 3 programmable privacy masks
Focal Length	4 mm
Aperture Range	F1.6
FOV	Horizontal field of view: 80.7° × 3 Vertical field of view: 43.5°
IR Radius	30 m
PTZ Camera	
Image Sensor	1/2.8" progressive scan CMOS
Min. Illumination	Color: 0.005 Lux @(F1.6, AGC ON) B/W: 0.001 Lux @(F1.6, AGC ON) 0 Lux with IR
Shutter Time	50 Hz: 1/25 s to 1/30,000 s 60 Hz: 1/30 s to 1/30,000 s
Day & Night	IR Cut Filter
Gain	Auto/Manual
WDR	Digital WDR
Smart Image Enhancement	HLC/BLC/3D DNR/Defog/Regional Exposure/Regional Focus
White Balance	Auto/Manual/ATW (Auto-Tracking White Balance)/Indoor/Outdoor/Fluorescent Lamp/Sodium Lamp
Privacy Mask	8 programmable privacy masks
Digital Zoom	8×
Focus Mode	Auto/Semi-automatic/Manual
Focal Length	4.7 mm to 47 mm, 10× optical zoom
Zoom Speed	Approx. 2.5 s (optical, wide - tele)
FOV	Horizontal field of view: 58.6° to 6.4° (wide - tele) Vertical field of view: 35.1° to 3.6° (wide - tele)

	Diagonal field of view: 7.4° to 65.6° (wide - tele)
Min. Working Distance	10 mm to 1500 mm (wide - tele)
Aperture Range	F1.6 to F3.0
Pan and Tilt Range	Pan: 0° to 350°; Tilt: 0° to 90°
Pan and Tilt Speed	Pan speed: 0.1°/s to 60°/s (configurable), preset speed: 60°/s Tilt speed: 0.1°/s to 60°/s (configurable), preset speed: 60°/s
3D Positioning	Yes
Proportional Zoom	Yes
Preset Number	300
Park Action	Preset
Power-off Memory	Yes
PTZ Status Display	Yes
Preset Freezing	Yes
Scheduled Task	Preset/Dome Reboot/Dome Adjust
IR Distance	50 m
Dual-VCA	Yes
Smart Event Detection	Audio Exception Detection, Intrusion Detection, Line Crossing Detection
System	
PTZ Linkage	Yes
SVC	Yes
ROI	Main stream and sub-stream respectively supports eight fixed areas.
Video Compression (Sub-stream enabled)	Panoramic camera: Main stream: H.265/H.264 Sub-stream: H.265/H.264 H.264 with Main Profile/High Profile, H.265 with Main Profile PTZ camera: Main stream: H.265/H.264 Sub-stream: H.265/H.264/MJPEG H.264 with Main Profile/High Profile, H.265 with Main Profile
Video Compression (Sub-stream not enabled)	Panoramic camera: Main stream: H.265/H.264 H.264 with Main Profile/High Profile, H.265 with Main Profile PTZ camera: Main stream: H.265/H.264/MJPEG H.264 with Main Profile/High Profile, H.265 with Main Profile
Video Bitrate	256 Kbps to 8192 Kbps
Audio Compression	G.711alaw/G.711ulaw/G.722.1/G.726/MP2L2
Audio Bitrate	G.711alaw/G.711ulaw: 64 Kbps G.722.1/G.726: 16 Kbps MP212: 32 Kbps/64 Kbps/128 Kbps
Resolution (Sub-stream enabled)	Panoramic camera: Main stream: 50 Hz: 20 fps (1920 × 1080, 1280 × 960, 1280 × 720) 60 Hz: 20 fps (1920 × 1080, 1280 × 960, 1280 × 720) Sub-stream: 50 Hz: 20 fps (704 × 576, 640 × 480, 352 × 288) 60 Hz: 20 fps (704 × 480, 640 × 480, 352 × 240) PTZ camera: Main stream: 50 Hz: 20 fps (1920 × 1080, 1280 × 960, 1280 × 720) 60 Hz: 20 fps (1920 × 1080, 1280 × 960, 1280 × 720) Sub-stream: 50 Hz: 20 fps (704 × 576, 640 × 480, 352 × 288) 60 Hz: 20 fps (704 × 480, 640 × 480, 352 × 240)

Resolution (Sub-stream not enabled)	Panoramic camera: Main stream: 50 Hz: 25 fps (1920 × 1080, 1280 × 960, 1280 × 720, 704 × 576, 640 × 480, 352 × 288) 60 Hz: 30 fps (1920 × 1080, 1280 × 960, 1280 × 720, 704 × 480, 640 × 480, 352 × 240) PTZ camera: Main stream: 50 Hz: 25 fps (1920 × 1080, 1280 × 960, 1280 × 720, 704 × 576, 640 × 480, 352 × 288) 60 Hz: 30 fps (1920 × 1080, 1280 × 960, 1280 × 720, 704 × 480, 640 × 480, 352 × 240)
Basic Event Detection	Motion Detection, Video Tampering Detection, Exception
Network	
Smart Record	ANR (Automatic Network Replenishment)
Network Storage	Built-in memory card slot, support Micro SD/SDHC/SDXC, up to 256 GB
Protocols	IPv4/IPv6, HTTP, HTTPS, 802.1x, Qos, FTP, SMTP, UPnP, SNMP, DNS, DDNS, NTP, RTSP, RTCP, RTP, TCP/IP, DHCP, PPPoE, Bonjour
API	Open-ended, support ONVIF, ISAPI, and CGI, support HIKVISION SDK and Third-Party Management Platform
Simultaneous Live View	Up to 4 × 4 channels
User/Host	Up to 32 users 3 levels: Administrator, Operator and User
Security Measures	User authentication (ID and PW), Host authentication (MAC address); HTTPS encryption; IEEE 802.1x port-based network access control; IP address filtering
Client	iVMS-4200, iVMS-4500, iVMS-5200, Hik-Connect
Web Browser	IE8 to 11, Chrome 31.0 to 44, Firefox 30.0 to 51
Interface	
Network Interface	1 RJ45 10 M/100 M Ethernet
Audio Interface	1-ch audio input and 1-ch audio output
Alarm Interface	1-ch alarm input and 1-ch alarm output
General	
Power	12 VDC, 3.33 A and Hi-PoE, 42.5 to 57 VDC, 1.41 A Max.27 W (Max. 9 W for IR)
Working Temperature	-30°C to 65°C (-22°F to 149°F), with heater on
Working Humidity	≤ 90%
Protection Level	IP66, 4000V Lightning Protection, Surge Protection and Voltage Transient Protection
Material	PC & Aluminum alloy
Dimensions	Φ 271.3 mm × 243.1 mm (Φ 10.68" × 9.57")
Weight	Approx. 3.2 kg (7.05 lb)

Available Model

DS-2PT5326IZ-DE (5-50 mm)(4 mm), 12 VDC & Hi-PoE

▪ Typical Application

Hikvision products are classified into three levels according to their anti-corrosion performance. Refer to the following description to choose for your using environment.

This model has NO SPECIFIC PROTECTION.

Level	Description
Top-level protection	Hikvision products at this level are equipped for use in areas where professional anti-corrosion

	protection is a must. Typical application scenarios include coastlines, docks, chemical plants, and more.
Moderate protection	Hikvision products at this level are equipped for use in areas with moderate anti-corrosion demands. Typical application scenarios include coastal areas about 2 kilometers (1.24 miles) away from coastlines, as well as areas affected by acid rain.
No specific protection	Hikvision products at this level are equipped for use in areas where no specific anti-corrosion protection is needed.

Dimensions

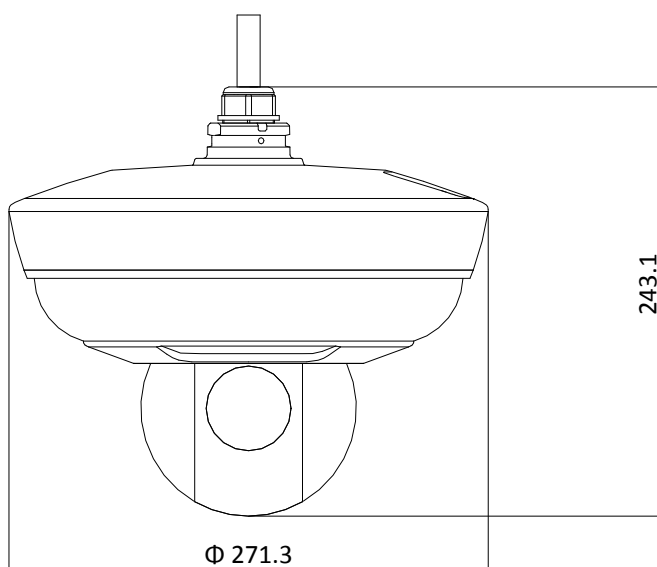

Unit: mm

Accessories



DS-1602ZJ

Wall Mounting Bracket



DS-1602ZJ-Pole

Vertical Pole Mounting Bracket



DS-1602ZJ-Corner

Corner Mounting Bracket



DS-1661ZJ

Pendant Mounting Bracket

Distributed by



HIKVISION®

Headquarters

No.555 Qianmo Road, Binjiang District,
Hangzhou 310051, China
T +86-571-8807-5998
overseasbusiness@hikvision.com

Hikvision USA
T +1-909-895-0400
sales.usa@hikvision.com

Hikvision Australia
T +61-2-8599-4233
salesau@hikvision.com

Hikvision India
T +91-22-28469900
sales@pramahikvision.com

Hikvision Canada
T +1-866-200-6690
sales.canada@hikvision.com

Hikvision Thailand
T +662-275-9949
sales.thailand@hikvision.com

Hikvision Europe
T +31-23-5542770
sales.eu@hikvision.com

Hikvision Italy
T +39-0438-6902
info.it@hikvision.com

Hikvision Brazil
T +55 11 3318-0050
Latam.support@hikvision.com

Hikvision Turkey
T +90 (216)521 7070- 7074
sales.tr@hikvision.com

Hikvision Malaysia
T +601-7652-2413
sales.my@hikvision.com

Hikvision UK & Ireland
T +01628-902140
sales.uk@hikvision.com

Hikvision South Africa
Tel: +27 (10) 0351172
sale.africa@hikvision.com

Hikvision France
T +33(0)1-85-330-450
info.fr@hikvision.com

Hikvision Kazakhstan
T +7-727-9730667
nikia.panfilov@hikvision.ru

Hikvision Vietnam
T +84-974270888
sales.vt@hikvision.com

Hikvision UAE
T +971-4-4432090
salesme@hikvision.com

Hikvision Singapore
T +65-6684-4718
sg@hikvision.com

Hikvision Spain
T +34-91-737-16-55
info.es@hikvision.com

Hikvision Tashkent
T +99-87-1238-9438
uzb@hikvision.ru

Hikvision Hong Kong
T +852-2151-1761
info.hk@hikvision.com

Hikvision Russia
T +7-495-669-67-99
saleru@hikvision.com

Hikvision Korea
T +82-(0)31-731-8817
sales.korea@hikvision.com

Hikvision Poland
T +48-22-460-01-50
info.pl@hikvision.com

Hikvision Indonesia
T +62-21-2933759
Sales.Indonesia@hikvision.com

Hikvision Colombia
sales.colombia@hikvision.com