

90° Asymmetrical Beam Antenna

HORN ANTENNA WITH N-FEMALE CONNECTORS

90° Asymmetrical Horn CC has radiation pattern narrow in the azimuth and wide in the elevation plane, greatly improving the coverage planning options. Increased gain and zero side lobes are suitable for rural deployments.

90° Asymmetrical Horn CC Antenna exceeds the traditional patch array sector antenna thanks to high stability of gain and radiation pattern in the whole bandwidth of operation. Outstanding noise rejection and precision of radiation pattern favor 90° Asymmetrical Horn CC antenna for high-density AP clusters and dense co-location sites. 90° Asymmetrical Horn CC Antenna features two N-female connectors.



TECHNICAL DATA

Radio Connection	2x N Female Bulkhead Connector
Antenna Type	Horn
Materials	UV Resistant ABS Plastic, Polycarbonate, HDPE, Aluminium, Stainless Steel
Environmental	IP55
Pole Mounting Diameter	36-80 mm (recommend as close to 80mm as possible)
Temperature	-35°C to +55°C (-31°F to +131°F)
Wind Survival	160 km/hour
Wind Loading	76 N at 160 km/hour
Mechanical Adjustment	± 25° Elevation, ± 20° Azimuth
Weight	5.5 kg / 12.1 lbs – single unit* 7.5 kg / 16.5 lbs – single unit incl. package*
Single Unit	Retail Box: 485 × 420 × 190 mm / 19.0 × 16.5 × 7.5 inch*

PRODUCT DIMENSIONS

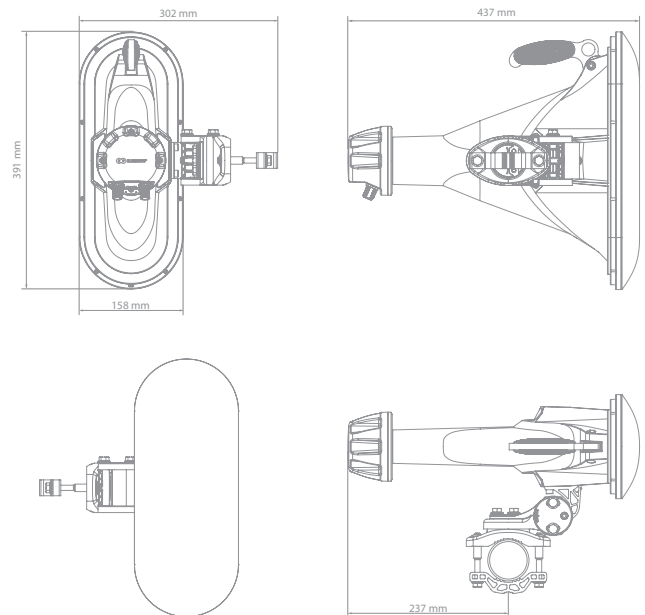

PERFORMANCE

Frequency Range	5180 - 6000 MHz
Gain	16 dBi
Azimuth Beam Width -3 dB	H 60° / V 60°
Elevation Beam Width -3 dB	H 16° / V 16°
Azimuth Beam Width -6 dB	H 90° / V 90°
Elevation Beam Width -6 dB	H 25° / V 25°
Beam Efficiency**	90 %
Front-to-Back Ratio	30 dB
VSWR Max 5180-6000 MHz	1.8
Polarization	Dual Linear H + V
Impedance	50 Ohm

AZIMUTH PATTERN

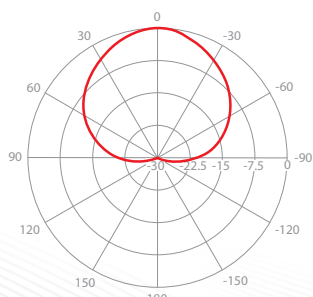

V/H - Port Pattern Azimuth 5.6 GHz

ELEVATION PATTERN



V/H - Port Pattern Elevation 5.6 GHz

GAIN

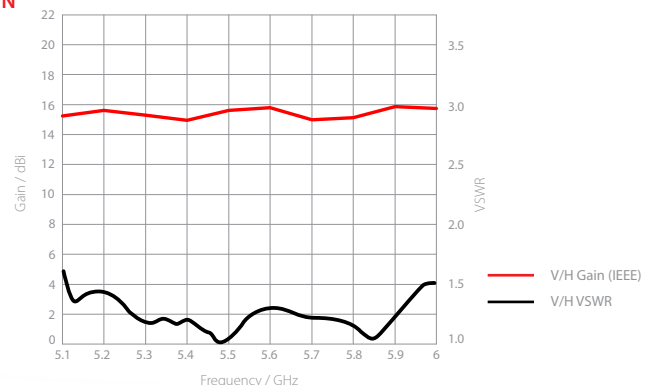

*Subject to change, **Main beam defined up to first null