



**UniFi**® | Antenna

Directional Dual-Band Antenna  
for UAP-AC-M

Model: UMA-D

SICE DISTRIBUTORE UFFICIALE: [www.sicetelecom.it](http://www.sicetelecom.it)

QUICK START GUIDE

## Introduction

Thank you for purchasing the Ubiquiti Networks® UniFi® 802.11ac Indoor/Outdoor Mesh Antenna. This Quick Start Guide is designed to guide you through installation and includes warranty terms.

## Package Contents



UMA-D Antenna



Ball Joint Mount



Lock Ring



Screws  
(Qty. 4)



Screw Anchors  
(Qty. 4)



Hex Bolt



Wall Mount  
Plate



Metal Strap



RF Cables  
(Qty. 2)



Quick Start  
Guide

**TERMS OF USE:** Ubiquiti radio devices must be professionally installed. Shielded Ethernet cable and earth grounding must be used as conditions of product warranty. TOUGHcable™ is designed for outdoor installations. It is the professional installer's responsibility to follow local country regulations, including operation within legal frequency channels, output power, and Dynamic Frequency Selection (DFS) requirements.

**SICE DISTRIBUTORE UFFICIALE:** [www.sicetelecom.it](http://www.sicetelecom.it)

## Installation Requirements

- UniFi AC Mesh Access Point, model UAP-AC-M
- Wall-mounting: drill and 6 mm drill bit
- Pole-mounting: 7 mm socket wrench
- Phillips screwdriver
- Shielded Category 5 (or above) cabling with drain wire should be used for all outdoor wired Ethernet connections and should be grounded through the AC ground of the PoE.

We recommend that you protect your networks from harmful outdoor environments and destructive ESD events with industrial-grade, shielded Ethernet cable from Ubiquiti Networks. For more details, visit [www.ubnt.com/toughcable](http://www.ubnt.com/toughcable)

- Surge protection should be used for all outdoor installations. We recommend that you use two Ethernet Surge Protectors, model ETH-SP, one near the UAP-AC-M and the other at the entry point to the building. The ETH-SP will absorb power surges and safely discharge them into the ground.

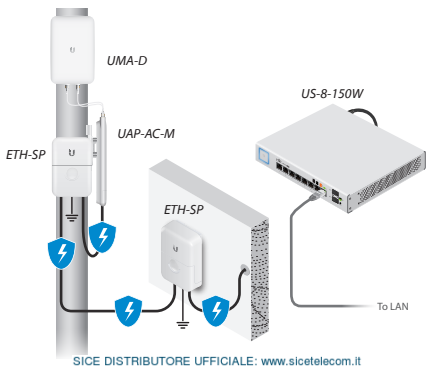

Diagram Showing Use of Ethernet Surge Protectors

## Hardware Installation

The UniFi antenna can be mounted on a wall or pole. Perform the following steps for proper installation:

### Wall Mount

To mount the UniFi antenna on a wall, use the included *Wall Mount Plate*, *Screws*, and *Screw Anchors*.

1. Place the *Wall Mount Plate* at the desired location on the wall in the orientation shown below.
2. Pre-drill the holes using a 6 mm drill bit.
3. Insert a *Screw Anchor* into each hole.
4. Secure the *Wall Mount Plate* with four *Screws*.

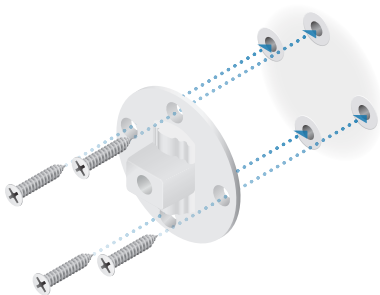

5. Insert the *Ball Joint Mount* into the *Lock Ring*.

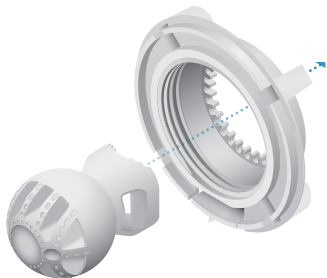

6. Secure the *Ball Joint Mount* to the *Wall Mount Plate* using the *Hex Bolt*.



7. Attach the antenna to the *Ball Joint Mount* and turn the *Lock Ring* to secure it. Keep the *Lock Ring* loose enough to allow the antenna to pivot for aiming.



8. Connect one end of the *RF Cables* to the antenna.



9. Connect the other end of the *RF Cables* to the UAP-AC-M.



SICE DISTRIBUTORE UFFICIALE: [www.sicetelecom.it](http://www.sicetelecom.it)

## Pole Mount

1. Insert the *Ball Joint Mount* into the *Lock Ring* with the threads of the *Lock Ring* facing the ball joint.

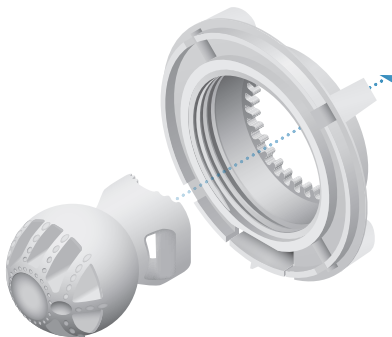

2. Open the *Metal Strap* and feed it through the base of the *Ball Joint Mount*.

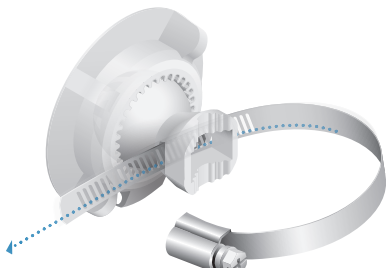



3. Wrap the *Metal Strap* around the pole. Use a 7 mm socket wrench to turn the screw clockwise and securely fasten the clamp to the pole.

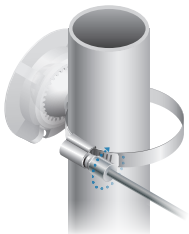

4. Attach the antenna to the *Ball Joint Mount* and turn the *Lock Ring* to secure it. Keep the *Lock Ring* loose enough to allow the antenna to pivot for aiming.

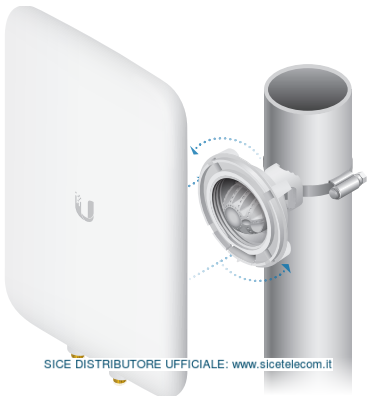

5. Connect one end of the *RF Cables* to the antenna.

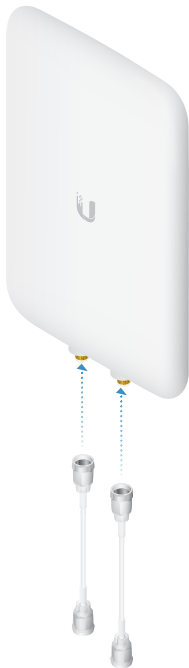

SICE DISTRIBUTORE UFFICIALE: [www.sicetelecom.it](http://www.sicetelecom.it)  
640-00331-03

6. Connect the other end of the *RF Cables* to the UAP-AC-M.



SICE DISTRIBUTORE UFFICIALE: [www.sicetelecom.it](http://www.sicetelecom.it)

## Specifications

UMA-D	
Dimensions	201.3 x 128.0 x 32.5 mm (7.93 x 5.04 x 1.28")
Weight	
With Mount	480 g (16.93 oz)
Without Mount	400 g (14.11 oz)
Enclosure	Outdoor UV Stabilized Plastic
Supported Frequency Range	2.4 - 2.5 GHz 5.1 - 5.9 GHz
HPOL Beamwidth	
2.4 GHz	90°
5 GHz	45°
VPOL Beamwidth	
2.4 GHz	90°
5 GHz	45°
Elevation Beamwidth	
2.4 GHz	90°
5 GHz	45°
Maximum VSWR	2.5:1
Polarization	Dual-Linear
Cross-Pol Isolation	
2.4 GHz	25 dB
5 GHz	30 dB
Antenna Gain	
2.4 GHz	10 dBi
5 GHz	15 dBi
Mounting	Wall/Pole (Kits Included)

## Safety Notices

1. Read, follow, and keep these instructions.
2. Heed all warnings.
3. Only use attachments/accessories specified by the manufacturer.



**WARNING:** Do not use this product in a location that can be submerged by water.



**WARNING:** Avoid using this product during an electrical storm. There may be a remote risk of electric shock from lightning.

## Electrical Safety Information

1. Compliance is required with respect to voltage, frequency, and current requirements indicated on the manufacturer's label. Connection to a different power source than those specified may result in improper operation, damage to the equipment or pose a fire hazard if the limitations are not followed.
2. There are no operator serviceable parts inside this equipment. Service should be provided only by a qualified service technician.

## Limited Warranty

UBIQUITI NETWORKS, Inc (“UBIQUITI NETWORKS”) warrants that the product(s) furnished hereunder (the “Product(s)”) shall be free from defects in material and workmanship for a period of one (1) year from the date of shipment by UBIQUITI NETWORKS under normal use and operation. UBIQUITI NETWORKS’ sole and exclusive obligation and liability under the foregoing warranty shall be for UBIQUITI NETWORKS, at its discretion, to repair or replace any Product that fails to conform to the above warranty during the above warranty period. The expense of removal and reinstallation of any Product is not included in this warranty. The warranty period of any repaired or replaced Product shall not extend beyond its original term.

## Warranty Conditions

The above warranty does not apply if the Product:

- (I) has been modified and/or altered, or an addition made thereto, except by Ubiquiti Networks, or Ubiquiti Networks’ authorized representatives, or as approved by Ubiquiti Networks in writing;
- (II) has been painted, rebranded or physically modified in any way;
- (III) has been damaged due to errors or defects in cabling;
- (IV) has been subjected to misuse, abuse, negligence, abnormal physical, electromagnetic or electrical stress, including lightning strikes, or accident;
- (V) has been damaged or impaired as a result of using third party firmware;
- (VI) has no original Ubiquiti MAC label, or is missing any other original Ubiquiti label(s); or
- (VII) has not been received by Ubiquiti within 30 days of issuance of the RMA.

In addition, the above warranty shall apply only if: the product has been properly installed and used at all times in accordance, and in all material respects, with the applicable Product documentation; all Ethernet cabling runs use CAT5 (or above), and for outdoor installations, shielded Ethernet cabling is used, and for indoor installations, indoor cabling requirements are followed.

## Returns

No Products will be accepted for replacement or repair without obtaining a Return Materials Authorization (RMA) number from UBIQUITI NETWORKS during the warranty period, and the Products being received at UBIQUITI NETWORKS' facility freight prepaid in accordance with the RMA process of UBIQUITI NETWORKS. Products returned without an RMA number will not be processed and will be returned freight collect or subject to disposal. Information on the RMA process and obtaining an RMA number can be found at: [www.ubnt.com/support/warranty](http://www.ubnt.com/support/warranty)

## Disclaimer

EXCEPT FOR ANY EXPRESS WARRANTIES PROVIDED HEREIN, UBIQUITI NETWORKS, ITS AFFILIATES, AND ITS AND THEIR THIRD PARTY DATA, SERVICE, SOFTWARE AND HARDWARE PROVIDERS HEREBY DISCLAIM AND MAKE NO OTHER REPRESENTATION OR WARRANTY OF ANY KIND, EXPRESS, IMPLIED OR STATUTORY, INCLUDING, BUT NOT LIMITED TO, REPRESENTATIONS, GUARANTEES, OR WARRANTIES OF MERCHANTABILITY, ACCURACY, QUALITY OF SERVICE OR RESULTS, AVAILABILITY, SATISFACTORY QUALITY, LACK OF VIRUSES, QUIET ENJOYMENT, FITNESS FOR A PARTICULAR PURPOSE AND NON-INFRINGEMENT AND ANY WARRANTIES ARISING FROM ANY COURSE OF DEALING, USAGE OR TRADE PRACTICE IN CONNECTION WITH SUCH PRODUCTS AND SERVICES. BUYER ACKNOWLEDGES THAT NEITHER UBIQUITI NETWORKS NOR ITS THIRD PARTY PROVIDERS CONTROL BUYER'S EQUIPMENT OR THE TRANSFER OF DATA OVER COMMUNICATIONS FACILITIES, INCLUDING THE INTERNET, AND THAT THE PRODUCTS AND SERVICES MAY BE SUBJECT TO LIMITATIONS, INTERRUPTIONS, DELAYS, CANCELLATIONS AND OTHER PROBLEMS INHERENT IN THE USE OF COMMUNICATIONS FACILITIES. UBIQUITI NETWORKS, ITS AFFILIATES AND ITS AND THEIR THIRD PARTY PROVIDERS ARE NOT RESPONSIBLE FOR ANY INTERRUPTIONS, DELAYS, CANCELLATIONS, DELIVERY FAILURES, DATA LOSS, CONTENT CORRUPTION, PACKET LOSS, OR OTHER DAMAGE RESULTING FROM ANY OF THE FOREGOING. In addition, UBIQUITI NETWORKS does not warrant that the operation of the Products will be error-free or that operation will be uninterrupted. In no event shall UBIQUITI NETWORKS be responsible for damages or claims of any nature or description relating to system performance, including coverage, buyer's selection of products (including the Products) for buyer's application and/or failure of products (including the Products) to meet government or regulatory requirements.

## Limitation of Liability

EXCEPT TO THE EXTENT PROHIBITED BY LOCAL LAW, IN NO EVENT WILL UBIQUITI OR ITS SUBSIDIARIES, AFFILIATES OR SUPPLIERS BE LIABLE FOR DIRECT, SPECIAL, INCIDENTAL, CONSEQUENTIAL OR OTHER DAMAGES (INCLUDING LOST PROFIT, LOST DATA, OR DOWNTIME COSTS), ARISING OUT OF THE USE, INABILITY TO USE, OR THE RESULTS OF USE OF THE PRODUCT, WHETHER BASED IN WARRANTY, CONTRACT, TORT OR OTHER LEGAL THEORY, AND WHETHER OR NOT ADVISED OF THE POSSIBILITY OF SUCH DAMAGES.

### Note

Some countries, states and provinces do not allow exclusions of implied warranties or conditions, so the above exclusion may not apply to you. You may have other rights that vary from country to country, state to state, or province to province. Some countries, states and provinces do not allow the exclusion or limitation of liability for incidental or consequential damages, so the above limitation may not apply to you. EXCEPT TO THE EXTENT ALLOWED BY LOCAL LAW, THESE WARRANTY TERMS DO NOT EXCLUDE, RESTRICT OR MODIFY, AND ARE IN ADDITION TO, THE MANDATORY STATUTORY RIGHTS APPLICABLE TO THE LICENSE OF ANY SOFTWARE (EMBEDDED IN THE PRODUCT) TO YOU. The United Nations Convention on Contracts for the International Sale of Goods shall not apply to any transactions regarding the sale of the Products.

## Compliance

### RF Exposure Warning

The antenna and transmitter must be installed to provide a separation distance from all persons and must not be located or operating in conjunction with any other antenna or transmitter. For the specific separation distance, refer to the Quick Start Guide for your UniFi device (transmitter).

L'antenne et l'émetteur doit être installé pour fournir une distance de séparation de toute les personnes et ne doit pas être situé ou opérant en conjonction avec une autre antenne ou un autre émetteur. Pour la distance spécifique de séparation, se référer au Guide de démarrage rapide pour votre appareil UniFi (l'émetteur).



## RoHS/WEEE Compliance Statement



### English

European Directive 2012/19/EU requires that the equipment bearing this symbol on the product and/or its packaging must not be disposed of with unsorted municipal waste. The symbol indicates that this product should be disposed of separately from regular household waste streams. It is your responsibility to dispose of this and other electric and electronic equipment via designated collection facilities appointed by the government or local authorities. Correct disposal and recycling will help prevent potential negative consequences to the environment and human health. For more detailed information about the disposal of your old equipment, please contact your local authorities, waste disposal service, or the shop where you purchased the product.

### Deutsch

Die Europäische Richtlinie 2012/19/EU verlangt, dass technische Ausrüstung, die direkt am Gerät und/oder an der Verpackung mit diesem Symbol versehen ist, nicht zusammen mit unsortiertem Gemeindeabfall entsorgt werden darf. Das Symbol weist darauf hin, dass das Produkt von regulärem Haushaltsmüll getrennt entsorgt werden sollte. Es liegt in Ihrer Verantwortung, dieses Gerät und andere elektrische und elektronische Geräte über die dafür zuständigen und von der Regierung oder örtlichen Behörden dazu bestimmten Sammelstellen zu entsorgen. Ordnungsgemäßes Entsorgen und Recyceln trägt dazu bei, potentielle negative Folgen für Umwelt und die menschliche Gesundheit zu vermeiden. Wenn Sie weitere Informationen zur Entsorgung Ihrer Altgeräte benötigen, wenden Sie sich bitte an die örtlichen Behörden oder städtischen Entsorgungsdienste oder an den Händler, bei dem Sie das Produkt erworben haben.

## Español

La Directiva 2012/19/UE exige que los equipos que lleven este símbolo en el propio aparato y/o en su embalaje no deben eliminarse junto con otros residuos urbanos no seleccionados. El símbolo indica que el producto en cuestión debe separarse de los residuos domésticos convencionales con vistas a su eliminación. Es responsabilidad suya desechar este y cualesquiera otros aparatos eléctricos y electrónicos a través de los puntos de recogida que ponen a su disposición el gobierno y las autoridades locales. Al desechar y reciclar correctamente estos aparatos estará contribuyendo a evitar posibles consecuencias negativas para el medio ambiente y la salud de las personas. Si desea obtener información más detallada sobre la eliminación segura de su aparato usado, consulte a las autoridades locales, al servicio de recogida y eliminación de residuos de su zona o pregunte en la tienda donde adquirió el producto.

## Français

La directive européenne 2012/19/UE exige que l'équipement sur lequel est apposé ce symbole sur le produit et/ou son emballage ne soit pas jeté avec les autres ordures ménagères. Ce symbole indique que le produit doit être éliminé dans un circuit distinct de celui pour les déchets des ménages. Il est de votre responsabilité de jeter ce matériel ainsi que tout autre matériel électrique ou électronique par les moyens de collecte indiqués par le gouvernement et les pouvoirs publics des collectivités territoriales. L'élimination et le recyclage en bonne et due forme ont pour but de lutter contre l'impact néfaste potentiel de ce type de produits sur l'environnement et la santé publique. Pour plus d'informations sur le mode d'élimination de votre ancien équipement, veuillez prendre contact avec les pouvoirs publics locaux, le service de traitement des déchets, ou l'endroit où vous avez acheté le produit.

## Italiano

La direttiva europea 2012/19/UE richiede che le apparecchiature contrassegnate con questo simbolo sul prodotto e/o sull'imballaggio non siano smaltite insieme ai rifiuti urbani non differenziati. Il simbolo indica che questo prodotto non deve essere smaltito insieme ai normali rifiuti domestici. È responsabilità del proprietario smaltire sia questi prodotti sia le altre apparecchiature elettriche ed elettroniche mediante le specifiche strutture di raccolta indicate dal governo o dagli enti pubblici locali. Il corretto smaltimento ed il riciclaggio aiuteranno a prevenire conseguenze potenzialmente negative per l'ambiente e per la salute dell'essere umano. Per ricevere informazioni più dettagliate circa lo smaltimento delle vecchie apparecchiature in Vostro possesso, Vi invitiamo a contattare gli enti pubblici di competenza, il servizio di smaltimento rifiuti o il negozio nel quale avete acquistato il prodotto.

# Declaration of Conformity

**български [Bulgarian]** С настоящото UBIQUITI NETWORKS декларира, че този тип радиосъоръжение UMA-D е в съответствие с Директива 2011/65/ЕС. Цялостният текст на ЕС декларацията за съответствие може да се намери на следния интернет адрес: **[www.ubnt.com/compliance](http://www.ubnt.com/compliance)**

**Hrvatski [Croatian]** UBIQUITI NETWORKS ovime izjavljuje da je radijska oprema tipa UMA-D u skladu s Direktivom 2011/65/EU. Cjeloviti tekst EU izjave o sukladnosti dostupan je na sljedećoj internetskoj adresi: **[www.ubnt.com/compliance](http://www.ubnt.com/compliance)**

**Čeština [Czech]** Tímto UBIQUITI NETWORKS prohlašuje, že typ rádiového zařízení UMA-D je v souladu se směrnicí 2011/65/EU. Úplné znění EU prohlášení o shodě je k dispozici na této internetové adrese: **[www.ubnt.com/compliance](http://www.ubnt.com/compliance)**

**Dansk [Danish]** Hermed erklærer UBIQUITI NETWORKS, at radioudstyrstypen UMA-D er i overensstemmelse med direktiv 2011/65/EU. EU-overensstemmelseserklæringens fulde tekst kan findes på følgende internetadresse: **[www.ubnt.com/compliance](http://www.ubnt.com/compliance)**

**Nederlands [Dutch]** Hierbij verklaar ik, UBIQUITI NETWORKS, dat het type radioapparatuur UMA-D conform is met Richtlijn 2011/65/EU. De volledige tekst van de EU-conformiteitsverklaring kan worden geraadpleegd op het volgende internetadres: **[www.ubnt.com/compliance](http://www.ubnt.com/compliance)**

**English** Hereby, UBIQUITI NETWORKS declares that the radio equipment type UMA-D is in compliance with Directive 2011/65/EU. The full text of the EU declaration of conformity is available at the following internet address: **[www.ubnt.com/compliance](http://www.ubnt.com/compliance)**

**Eesti keel [Estonian]** Käesolevaga deklareerib UBIQUITI NETWORKS, et käesolev raadioseadme tüüp UMA-D vastab direktiivi 2011/65/EL nõuetele. ELi vastavusdeklaratsiooni täielik tekst on kättesaadav järgmisel internetiaadressil: **[www.ubnt.com/compliance](http://www.ubnt.com/compliance)**

**Suomi [Finnish]** UBIQUITI NETWORKS vakuuttaa, että radiolaitetyyppi UMA-D on direktiivin 2011/65/EU mukainen. EU-vaatimustenmukaisuusvakuutuksen täysimittainen teksti on saatavilla seuraavassa internetosoitteessa: **[www.ubnt.com/compliance](http://www.ubnt.com/compliance)**

**Français [French]** Le soussigné, UBIQUITI NETWORKS, déclare que l'équipement radioélectrique du type UMA-D est conforme à la directive 2011/65/UE. Le texte complet de la déclaration UE de conformité est disponible à l'adresse internet suivante: **[www.ubnt.com/compliance](http://www.ubnt.com/compliance)**

**Deutsch [German]** Hiermit erkläre UBIQUITI NETWORKS, dass der Funkanlagentyp UMA-D der Richtlinie 2011/65/EU entspricht. Der vollständige Text der EU-Konformitätserklärung ist unter der folgenden Internetadresse verfügbar: **[www.ubnt.com/compliance](http://www.ubnt.com/compliance)**

**Ελληνικά [Greek]** Με την παρούσα ο/η UBIQUITI NETWORKS, δηλώνει ότι ο ραδιοεξοπλισμός UMA-D πληροί την οδηγία 2011/65/ΕΕ. Το πλήρες κείμενο της δήλωσης συμμόρφωσης ΕΕ διατίθεται στην ακόλουθη ιστοσελίδα στο διαδίκτυο: **[www.ubnt.com/compliance](http://www.ubnt.com/compliance)**

**Magyar [Hungarian]** UBIQUITI NETWORKS igazolja, hogy a UMA-D típusú rádióberendezés megfelel a 2011/65/EU irányelvnek. Az EU-megfelelőségi nyilatkozat teljes szövege elérhető a következő internetes címen: **[www.ubnt.com/compliance](http://www.ubnt.com/compliance)**

**Íslenska [Icelandic]** Hér með lýsir UBIQUITI NETWORKS yfir því að UMA-D er í samræmi við grunnkröfur og aðrar kröfur, sem gerðar eru í tilskipun 2011/65/EU. Fullur texti ESB samræmisýfirlýsing er að finna á eftirfarandi netfangi: **[www.ubnt.com/compliance](http://www.ubnt.com/compliance)**

**Italiano [Italian]** Il fabbricante, UBIQUITI NETWORKS, dichiara che il tipo di apparecchiatura radio UMA-D è conforme alla direttiva 2011/65/UE. Il testo completo della dichiarazione di conformità UE è disponibile al seguente indirizzo Internet: **[www.ubnt.com/compliance](http://www.ubnt.com/compliance)**

**Latviešu valoda [Latvian]** Ar šo UBIQUITI NETWORKS deklarē, ka radioiekārta UMA-D atbilst Direktīvai 2011/65/ES. Pilns ES atbilstības deklarācijas teksts ir pieejams šādā interneta vietnē: **[www.ubnt.com/compliance](http://www.ubnt.com/compliance)**

**Lietuvių kalba [Lithuanian]** Aš, UBIQUITI NETWORKS, patvirtinu, kad radijo įrenginių tipas UMA-D atitinka Direktyvą 2011/65/ES. Visas ES atitikties deklaracijos tekstas prieinamas šiuo interneto adresu: **[www.ubnt.com/compliance](http://www.ubnt.com/compliance)**

SICE DISTRIBUTORE UFFICIALE: **[www.sicetelecom.it](http://www.sicetelecom.it)**

**Malti [Maltese]** B'dan, UBIQUITI NETWORKS, niddikjara li dan it-tip ta' taghmir tar-radju UMA-D huwa konformi mad-Direttiva 2011/65/UE. Id-dikjarazzjoni tal-konformità tista' tiġi kkonsultata minn [www.ubnt.com/compliance](http://www.ubnt.com/compliance)

**Norsk [Norwegian]** UBIQUITI NETWORKS erklærer herved at utstyret UMA-D er i samsvar med de grunnleggende krav og øvrige relevante krav i direktiv 2011/65/EU. Den fulle teksten til EU-samsvarserklæringen er tilgjengelig på følgende internettsadresse: [www.ubnt.com/compliance](http://www.ubnt.com/compliance)

**Polski [Polish]** UBIQUITI NETWORKS niniejszym oświadczam, że typ urządzenia radiowego UMA-D jest zgodny z dyrektywą 2011/65/UE. Pełny tekst deklaracji zgodności UE jest dostępny pod następującym adresem internetowym: [www.ubnt.com/compliance](http://www.ubnt.com/compliance)

**Português [Portuguese]** O(a) abaixo assinado(a) UBIQUITI NETWORKS declara que o presente tipo de equipamento de rádio UMA-D está em conformidade com a Diretiva 2011/65/UE. O texto integral da declaração de conformidade está disponível no seguinte endereço de Internet: [www.ubnt.com/compliance](http://www.ubnt.com/compliance)

**Română [Romanian]** Prin prezenta, UBIQUITI NETWORKS declară că tipul de echipament radio UMA-D este în conformitate cu Directiva 2011/65/UE. Textul integral al declarației UE de conformitate este disponibil la următoarea adresă internet: [www.ubnt.com/compliance](http://www.ubnt.com/compliance)

**Slovenčina [Slovak]** UBIQUITI NETWORKS týmto vyhlasuje, že rádiové zariadenie typu UMA-D je v súlade so smernicou 2011/65/EÚ. Úplné EÚ vyhlásenie o zhode je k dispozícii na tejto internetovej adrese: [www.ubnt.com/compliance](http://www.ubnt.com/compliance)

**Slovenščina [Slovenian]** UBIQUITI NETWORKS potrjuje, da je tip radijske opreme UMA-D skladen z Direktivo 2011/65/EU. Celotno besedilo izjave EU o skladnosti je na voljo na naslednjem spletnem naslovu: [www.ubnt.com/compliance](http://www.ubnt.com/compliance)

**Español [Spanish]** Por la presente, UBIQUITI NETWORKS declara que el tipo de equipo radioeléctrico UMA-D es conforme con la Directiva 2011/65/UE. El texto completo de la declaración UE de conformidad está disponible en la dirección Internet siguiente: [www.ubnt.com/compliance](http://www.ubnt.com/compliance)

**Svenska [Swedish]** Härmed försäkras UBIQUITI NETWORKS att denna typ av radioutrustning UMA-D överensstämmer med direktiv 2011/65/EU. Den fullständiga texten till EU-försäkran om överensstämmelse finns på följande webbadress: [www.ubnt.com/compliance](http://www.ubnt.com/compliance)

## Online Resources

Website [www.ubnt.com](http://www.ubnt.com)  
Support [help.ubnt.com](http://help.ubnt.com)  
Community [community.ubnt.com](http://community.ubnt.com)  
Downloads [downloads.ubnt.com](http://downloads.ubnt.com)

Ubiquiti Networks, Inc.  
685 Third Avenue, 27th Floor  
New York, NY 10017  
USA



©2017-2018 Ubiquiti Networks, Inc. All rights reserved. Ubiquiti, Ubiquiti Networks, the Ubiquiti U logo, the Ubiquiti beam logo, TOUGHCable, and UniFi are trademarks or registered trademarks of Ubiquiti Networks, Inc. in the United States. **SICE DISTRIBUTORE UFFICIALE:** [www.sicetelecom.it](http://www.sicetelecom.it) property of their respective owners.

JLAJ030218